

Intelligent Digital Display Controller



Contents

1. Technical specifications.....	3
2. Overall dimension & opening dimension	4
3. Panel operating instructions.....	5
4. Operation flow chart.....	6
5. Primary control parameters.....	7
6. Secondary internal parameters.....	7
7. Entering index type table.....	9

1. Technical specifications

- Input signal: Thermocouple: B,S,K,E,T,J,WRe...etc;
Thermal resistance: PT100,Cu50, Cu10...etc;
Voltage: 0~5V, 1~5V, 0~10V;
Current: 0~10mA, 0~20mA, 4~20mA;
Linear resistance: 0~400Ω.
- Output function: Analog output: Voltage or current(Optional);
Communication output: RS485;
Supports 2-way or 4-way relay output.
- Accuracy: 0.5%FS(Default)
- Measuring range: -1999~9999 measurement value display
- Power method: DC24V (switch power supply);
AC220V (linear power supply).
- Display type: -1999~9999 measurement value display;
-999~9999 set value display;
Current channel AH and AL alarm value display;
Led working status display;
High brightness LED digital display.
- Output signal: DC 0~10mA (Load resistance≤750Ω);
DC 4~20mA (Load resistance≤500Ω);
DC 0~5V (Load resistance≤250Ω);
DC 1~5V (Load resistance≤250Ω).

- Switch output: Relay controls output (AC220V/3A,DC24V/5A)
- Alarm type: 2-way relay alarm output, LED indicator.
- Setting method: Panel touch button digital setting;
 - Set value stored permanently after power off;
 - Password lock the parameter settings.
- Power consumption: $\leq 3W$ (DC24V switch power supply)
 - $\leq 5W$ (AC220 linear power supply)
- Usage ambient: Temperature: 0~50°C
 - Relative humidity: $\leq 85RH$

2. Overall dimension & opening dimension

Panel size	LED size	Overall dimension (mm)	Opening dimension (mm)
48*48	0.36" (red)	48*48*110 (square)	45*45
48*96	0.39" (red)	48*96*110 (vertical)	45*92
96*48	0.52" (red)	96*48*110 (horizontal)	92*45
72*72	0.52" (red)	72*72*110 (square)	68*68
96*96	0.80" (red)	96*96*110 (square)	92*92
80*160	0.52" (red)	80*160*93 (vertical)	76*152
160*80	0.80" (red)	160*80*93 (horizontal)	152*76

3. Panel operating instructions

① Alarm indicator	AH(Alarm of High),AL(Alarm of Low), AHH(Alarm of High High),ALL(Alarm of Low Low),
Alarm indicator will light up if the 4-way relay alarm has output.	
② Beam	0%~100% matches with the percentage of measuring range
③ Set key	In the parameters setting state, save the parameters. Press three seconds to enter the setting state.
④ Increase key	In the parameters setting state, press to increase. View parameters internally clockwise.
⑤ Decrease key	In the parameters setting state, press to decrease. View parameters internally counterclockwise.
⑥ Shift key	In the parameter setting state, press to shift the flashing cursor.
When customize buzzer alarm, it can be used as mute button	
⑦ Display screen	Display real-time measurement value, internal state display, parameter symbol.

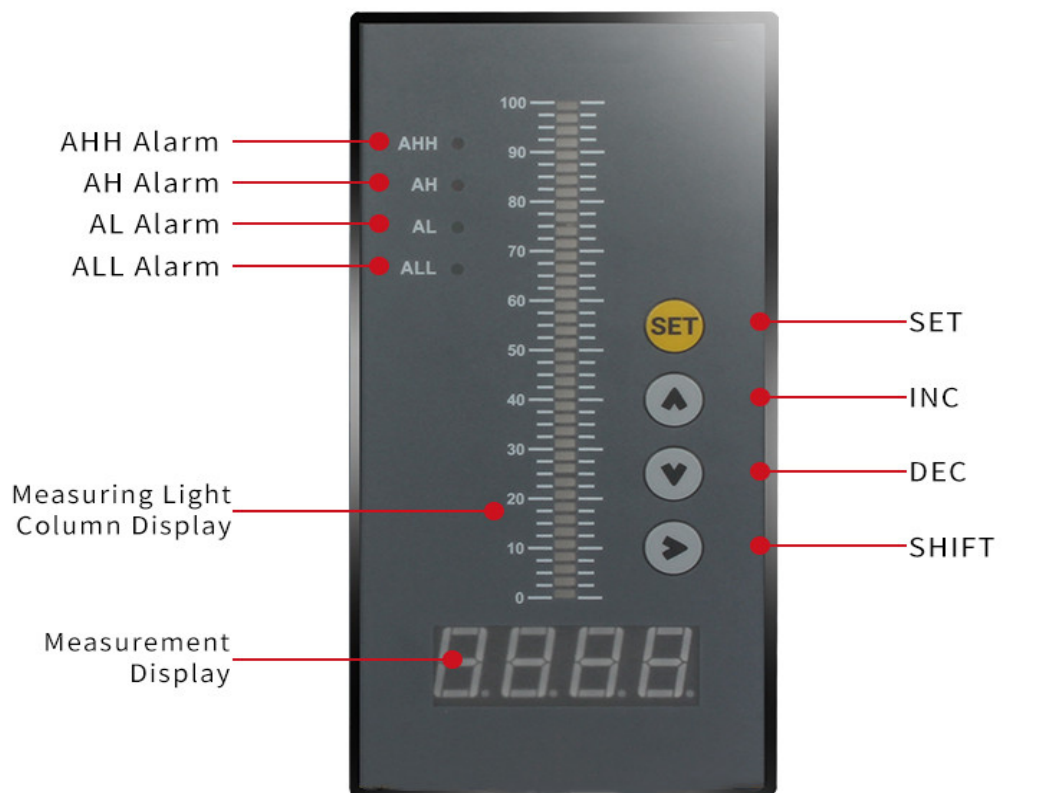





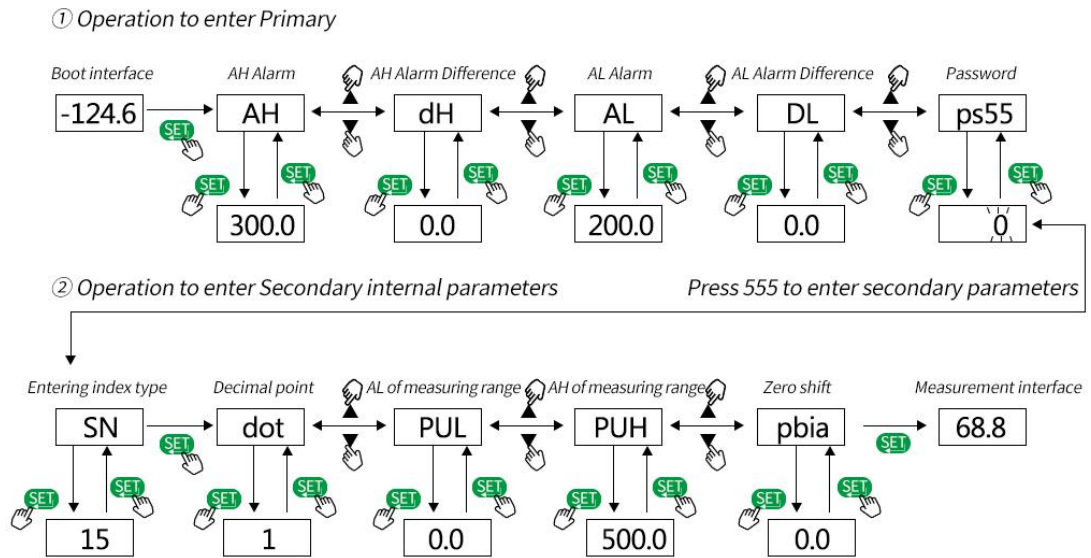



- LED Quantity Display Measuring Instrument
- High Brightness Light Column of Display Measured Value
- Input Signal Type Setting
- Alarm Mode Setting
- Zero and Span Range Setting of Measured Value
- Output Mode Setting

4. Operation flow chart



③ Setting key points

- Press  to enter setting; press  to conserve; use    to enter password and parameters setting values.
- Press  to move the cursor; press  to move to next page clockwise, or decrease the setting value; press  to move to next page counterclockwise, or increase the setting value.

5. Primary control parameters

●(How to enter primary control parameters, please refer to the Operation flow chart)

Symbol	Function	Range	Explanation	Factory Default
AH	AH Alarm Value	-1999~9999	Show the Alarm Value of AH Alarm	300.0 or 50.0
dH	AH Alarm Difference	0~9999	Show the Difference Value of AH Alarm	0.0 or 2.0
AL	AL Alarm Value	-1999~9999	Show the Alarm Value of AL Alarm	200.0 or 100.0
dL	AL Alarm Difference	0~9999	Show the Alarm Difference of AL Alarm	0.0 or 2.0
AHH	AHH Alarm Value	-1999~9999	Show the Alarm Value of AHH Alarm	400.0 or 50.0
dHH	AHH Alarm Difference	0~9999	Show the Alarm Difference of AHH Alarm	0.0 or 2.0
ALL	ALL Alarm Value	-1999~9999	Show the Alarm Value of ALL Alarm	100.0 or 50.0
dLL	ALL Alarm Difference	0~9999	Show the Alarm Difference of ALL Alarm	0.0 or 2.0
pass	Secondary menu password	Pass=555	Enter the secondary menu setting	0

6. Secondary internal parameters

●(How to enter secondary internal parameters, please refer to the Operation flow chart. DO NOT modify it if you're not engineer, to avoid instrument control error)●

Symbol	Function	Range	Explanation
Sn	Entering index type	0~22	Entering index type (As the following table shows)
dot	Decimal point	dot=0	no
		dot=1	Decimal point is in ten digit (XXX.X)
		dot=2	Decimal point is in hundred digit (XX.XX)
		dot=3	Decimal point is in thousand digit (X.XXX)
pul	AL of measuring range	-1999~9999	Set the AL measuring range of input signal
puh	AH of measuring range	-1999~9999	Set the AH measuring range of input signal

pbia	Zero shift	Full range	Set the migration of input zero
filt	Filter coefficient	0.100~0.900	Setting can't exceed 0.900
K1	Display input scale	0~1.999 times	Set display input scale magnificatio
ou-a	Transmit output	ou-a=1(0~10mA)	Linear output of corresponding measured value
		ou-a=2(4~20mA)	
		ou-a=3(0~20mA)	
ou-l	Transmit/Al of beam rage	Full range	
ou-h	Transmit/AH of beam rage	Full range	
ph	AH alarm type	Hundred digit: 0 monitor PV	Factory default is 0001
		Ten digit: 0 alarm, relay close, 1 alarm, relay open	
		One digit: 0 stop alarming, 1 High alarm, 2 Low alarm	
pl	AL alarm type	Definition as same as ph	Factory default is 0002
phh	AL alarm type	Definition as same as ph	Factory default is 0001
pll	ALL alarm type	Definition as same as ph	Factory default is 0002
inph	Max value of non-standard signal	10~100mV, 10~400 Ω, 2~300Hz,	Factory default is 100.0
inpl	Min value of non-standard signal	0~90mV, 0~390 Ω, 0~298Hz,	Factory default is 0.0
baud	Communication baud rate	0=1200bps, 1=2400bps,	Usually the communication speed will be chose 3=9600bps.
		2=4800bps, 3=9600bps,	
id	Communication address	1~64	NO. Of equipment address

7. Entering index type table

Code	Input type	Measuring range	Code	Input type	Measuring range
00	S	0~1600°C	12	-----	Optional
01	R	0~1600°C	13	0~10mA	-999~9999
02	B	200~1800°C	14	0~20mA	-999~9999
03	K	0~1300°C	15	4~20mA	-999~9999
04	N	0~1300°C	16	mV non-standard signal	0~100mV
05	E	0~800°C	17	R non-standard signal	0~400 Ω
06	J	0~650°C	18	F non-standard signal	0~3000Hz
07	T	-200~400°C	19	0~5V root	-999~9999
08	PT100	-200~850°C	20	1~5V root	-999~9999
09	Cu50	-50~150°C	21	0~10mA root	-999~9999
10	0~5V	-999~9999	22	4~20mA root	-999~9999
11	1~5V	-999~9999	23	Full switch input	